

QAS 95 & 125 JD T4F

Mobile Generator



Standard Scope of Supply

The Atlas Copco **QAS 95 & 125 JD T4F** generators are prime power, multi-voltage, sound attenuated, mobile generators. They are powered by a John Deere Tier 4 Final, liquid-cooled, four-cylinder diesel engine.

The units consist of an alternator, diesel engine, cooling system, electrical distribution and control systems - all enclosed within a sound attenuated enclosure fabricated from powder coated steel with zinc rich primer. 6000 hr salt spray test.

A broad range of undercarriage formats and options are available.

Special attention has been given to the overall product quality, user friendliness, ease of serviceability, and economical operation to ensure best in class total cost of ownership.

Available Models

QAS 95 JD T4F
QAS 125 JD T4F

Multiple voltage – 95 kVA prime power – John Deere engine
Multiple voltage – 125 kVA prime power – John Deere engine

Standard Features

- Compact, sound attenuated, corrosion resistant enclosure with single point lifting and 110% fluid containment
- Available as a skid mounted unit with forklift pockets, or on a dual axle trailer
- Heavy Duty alternator with AREP excitation and marine grade protection
- DeepSea controller
- Single side servicing with long run filters and 500-hour service intervals
- John Deere 4045 engine with DOC & SCR after-treatment, ETM system and limited 5-year limited warranty
- Identical enclosures and maintenance points between both models
- Battery Charger (12V, 6A)
- External Fuel Tank connections (3-way valve) located inside the enclosure
- Emergency Stop
- Remote Start / Stop

Benefits

- Extremely durable and environmentally sensitive, designed to be used for everything from the oil patch to special event power
- Versatility, giving you the flexibility to match your machine to the correct application
- Start-up power for the most demanding sites with 300% over load starting capabilities
- Reliable and intuitive controls for ease of use and diagnostic capabilities
- Reduced total cost of ownership with easy access for mechanics
- Proven engine platform with high reliability and Exhaust Temperature Management system that minimizes the risks of wet stacking
- Reduces stock of service kits and inventory of parts with rental ROI kept in mind
- On board charger to ensure the battery is always ready for service
- Flexibility to work with an external and larger fuel tank for extended autonomy
- External, recessed emergency stop for increased safety
- Allows connection as a critical back-up unit via a 2-wire dry contact connection in the distribution panel

Technical Data ¹

Performance		QAS 95 JD	QAS 125 JD
Frequency	Hz	60	60
Rated prime power @ 480V 3Ø	kW/kVA	76 / 95	100 / 125
Rated standby power @ 480V 3Ø	kW/kVA	83 / 104	110 / 138
3Ø Power factor		0.8	0.8
3Ø Voltage in 480V switch position (series star w/neutral)	V	480Y / 277	480Y / 277
Amp capacity @480V	A	114	150
3Ø Voltage in 240-208V switch position (parallel star w/neutral)	V	240YY / 139-208YY	240YY / 139-208YY
Rated prime power @ 240V 3Ø	kW/kVA	76 / 95	100 / 125
Amp capacity @240V 3Ø	A	229	300
Rated prime power @208V 3Ø	kW/kVA	70 / 87	86.5 / 108
Amp capacity @208V 3Ø	A	242	300
Rated prime power 1Ø	kW/kVA	52 / 52	65 / 65
1Ø Power factor		1	1
1Ø Voltage in 120-240V switch position (Zig-Zag)	V	240 / 120	240 / 120
Amp Capacity @240V	A	217	271
Amp Capacity @120V	A	217 x 2	271 x 2
Main breaker – Rated Current In	A	400	400
Power distribution - Terminal board		5 Wire (L1, L2, L3, N, Ground)	5 Wire (L1, L2, L3, N, Ground)
Terminal board connections		Bare Wire Terminals	Bare Wire Terminals
Maximum terminal cable size		350MCM	350MCM
Convenience receptacles ²		2 x NEMA 5-20R GFCI & 3 x 125/250V 50A CS6369	2 x NEMA 5-20R GFCI & 3 x 125/250V 50A CS6369
Max. sound pressure level (LPA) @23' @75% Load ³	dB(A)	73	73
Fuel and DEF Systems			
Fuel consumption at 100% load (PRP)	gal / h	5.36	7.06
Fuel consumption at 75% load (PRP)	gal / h	4.23	5.65
Fuel tank capacity	gal	166	166
Fuel autonomy @75% load & 90% of fuel capacity	h	35.3	26.4
DEF Tank Capacity	Gal (L)	9.19 (34.8)	9.19 (34.8)
Alternator (4-pole, 12-wire)			
Brand / Model		Leroy Somer 44.3 S3	Leroy Somer 44.3 S5
Excitation system		AREP (auxiliary winding)	AREP (auxiliary winding)
Digital Automatic Voltage Regulator (± 0.25%)		Leroy Somer D350	Leroy Somer D350
Insulation		Class H	Class H
Engine			
Model		John Deere 4045 HFG04	John Deere 4045 HFG06
US EPA Family		MJDXL04.5315	MJDXL0.4.5311
US EPA Tier		Tier 4 Final	Tier 4 Final
Displacement	L	4.5	4.5
Cylinders		4	4
Continuous engine output	hp	122	157
Gross engine power output	hp	133	172
Speed	rpm	1800	1800
Engine control		ECU	ECU
Aspiration		Turbo w/Intercooler	Turbo w/Intercooler
Engine oil capacity ⁴	US gal	5.4	5.4
Engine coolant capacity	US gal	2.25	2.25
Max. ambient temperature (@Sea Level) ⁵	°F	122	122
Min. starting temperature (w/o cold weather options)	°F	14	14
Minimum starting temperature (with cold weather options) ⁶	°F	-13	-13
Electrical system (Negative ground)	V	12	12
Engine alternator output	A	90	90
Battery Capacity (Cold Cranking Amps)	A	1100	1100

¹ All ratings are at a reference condition of 0' altitude and 20°C (72°F)

² Please see receptacle voltage configuration in Power Distribution section on page #6

³ Measured in accordance with ISO 2151 under free field conditions @ 7m (23ft) distance

⁴ Engine oil to meet CJ-4 (low ash oil)

⁵ Please see "Derate Table" for altitude and temperature calculations on page #5

⁶ Cold weather option includes engine's variable speed fan and 0W40 synthetic oil. A 120V 1000W coolant heater comes as standard (no option needed).

Dimensions

Trailer Mounted

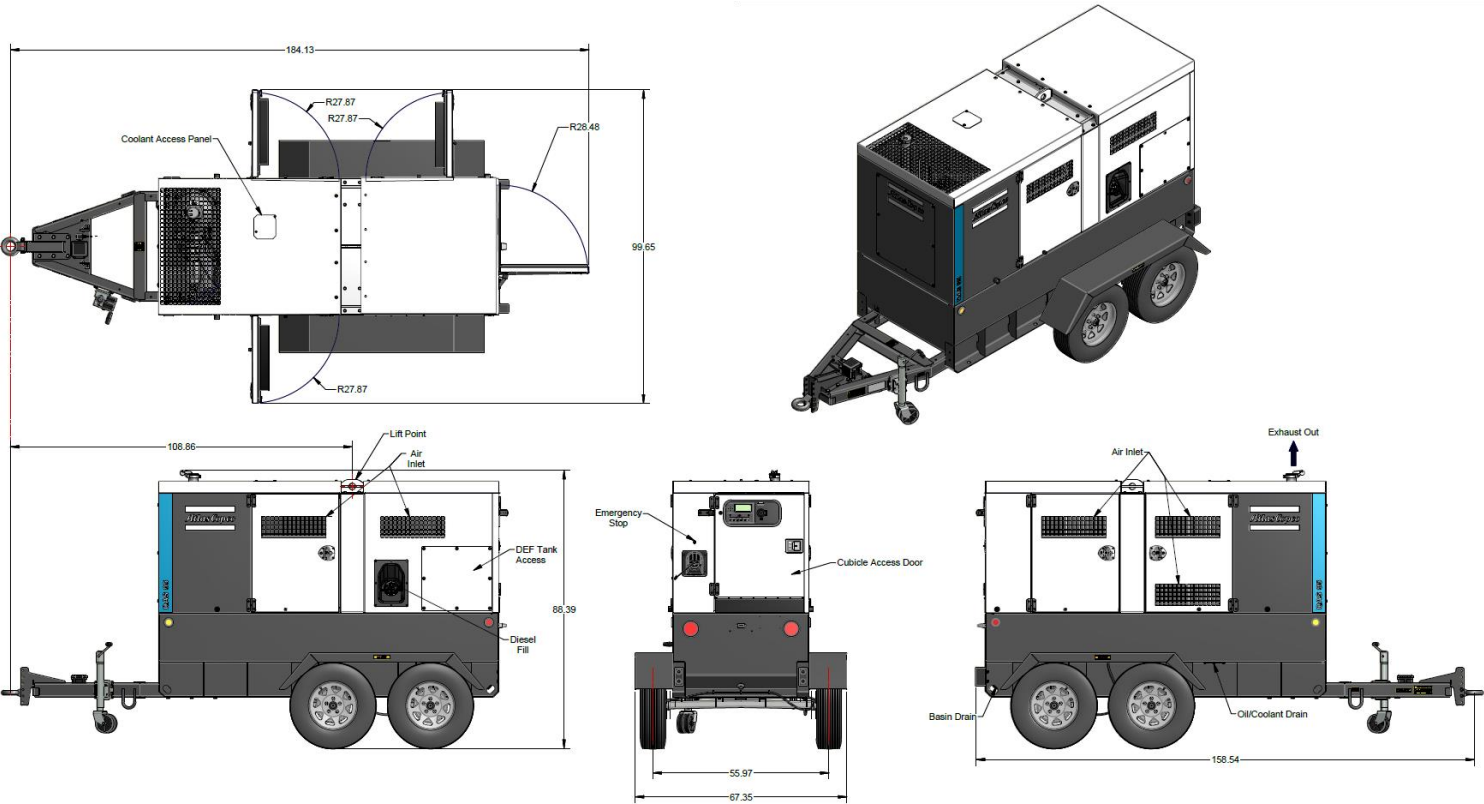

Weight	Units	QAS 95 JD	QAS 125 JD
Trailer Mounted – Wet (ready to operate)	Lbs (kg)	6,342 (2,877)	6,485 (2,942)
Trailer Mounted – Dry	Lbs (kg)	4,875 (2,211)	5,180 (2,350)

Dimensions	Inches	QAS 95 JD	QAS 125 JD
Trailer Mounted (L x W x H)		160 x 67 x 88	160 x 67 x 88

Dimensions

Skid Mounted

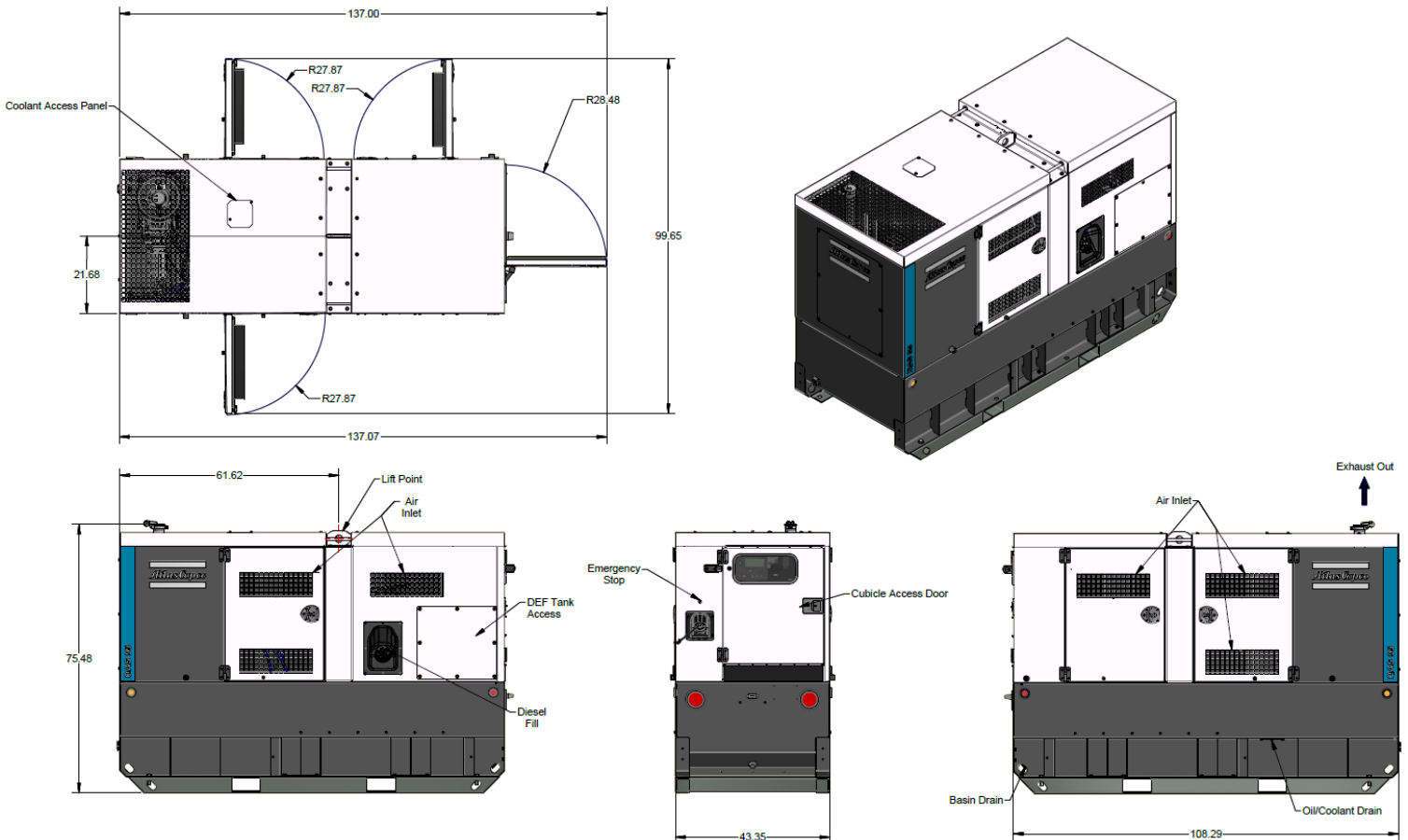

Weight

Skid Mounted – Wet (ready to operate)
Skid Mounted - Dry

Units

Lbs (kg)
Lbs (kg)

QAS 95 JD

5,442 (2,468)
3,975 (1,803)

QAS 125 JD

5,585 (2,533)
4,280 (1,941)

Dimensions

Skid Mounted (L x W x H)

Inches

108 x 43 x 76

108 x 43 x 76

Principle Data

Alternator

The Leroy Somer LSA alternators are designed for heavy duty continuous applications, with marine winding protection and AREP excitation system.

- AREP Excitation for superior motor starting capabilities
- Marine grade (relative humidity >95%) protection
- External multi-voltage selector switch (3-position)
- 4 pole brushless design with single bearing, Class H insulation and IP23 rating
- Voltage regulation +/- 0.25%
- Full Load acceptance of prime power rating

The AREP system uses 2 independent auxiliary windings located in the main stator to send supply voltage to the AVR:

- The voltage delivered by the first auxiliary winding H1 is proportional to the alternator output voltage (shunt characteristic).
- The voltage delivered by the second auxiliary winding H3 is proportional to the current drawn by the alternator and is a function of the applied load (compound characteristic – booster effect).
- The resulting phase-to-phase voltage supplies power to the AVR.

This power supply to the AVR power circuit is independent of the voltage sensing measured on the alternator output terminals. Therefore, the excitation current delivered by the AVR to the alternator exciter is independent of any voltage distortions (harmonics) due to the load. The AREP system gives the alternator a high overload capacity (load impact or starting electric motors) and a short-circuit capability (300% - 10 s) in order to provide discriminating protection: the alternator with AREP excitation is shorter than the one with PMG excitation. It is particularly suitable for demanding applications.

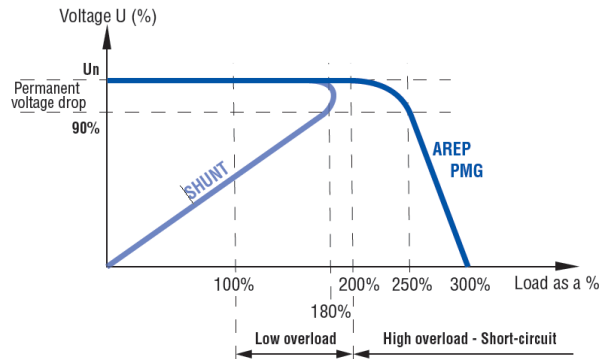
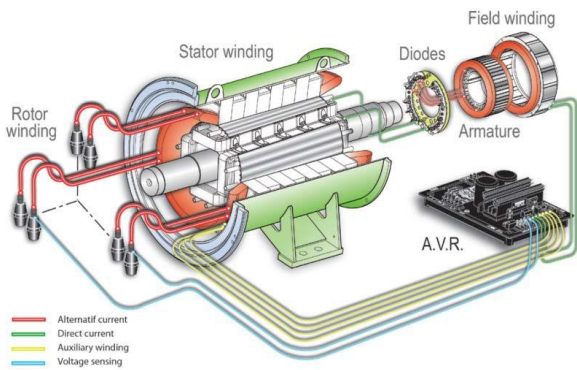

Performance @ Altitude and High Ambient Conditions

When using at altitude and high ambient conditions the engine and alternator will de-rate as per chart below.

QAS 95		Temperature °C (°F)									
Height m (Feet)	0 (32)	5 (41)	10 (50)	15 (59)	20 (68)	25 (77)	30 (86)	35 (95)	40 (104)	45 (113)	50 (122)
0	100%	100%	100%	100%	100%	100%	100%	100%	100%	95%	90%
500 (1640)	100%	100%	100%	100%	100%	100%	100%	100%	100%	95%	90%
1000 (3280)	100%	100%	100%	100%	100%	100%	100%	100%	100%	95%	90%
1500 (4921)	100%	100%	100%	100%	100%	100%	95%	95%	95%	90%	90%
2000 (6561)	100%	100%	100%	100%	100%	100%	90%	90%	90%	85%	85%
2500 (8202)	95%	95%	95%	95%	95%	95%	85%	85%	85%	80%	75%
3000 (9842)	95%	95%	95%	95%	95%	95%	85%	85%	85%	80%	75%
3500 (11,482)	90%	90%	90%	90%	90%	90%	75%	75%	75%	75%	70%
4000 (13,123)	85%	85%	85%	85%	85%	85%	75%	75%	75%	75%	70%
4500 (14,764)	75%	75%	75%	75%	75%	75%	70%	70%	70%	65%	65%
5000 (16,404)	65%	65%	65%	65%	65%	65%	65%	65%	65%	65%	65%









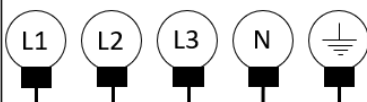

QAS 125		Temperature °C (°F)									
Height m (Feet)	0 (32)	5 (41)	10 (50)	15 (59)	20 (68)	25 (77)	30 (86)	35 (95)	40 (104)	45 (113)	50 (122)
0	100%	100%	100%	100%	100%	100%	100%	100%	100%	100%	95%
500 (1640)	100%	100%	100%	100%	100%	100%	100%	100%	100%	100%	95%
1000 (3280)	100%	100%	100%	100%	100%	100%	100%	100%	100%	100%	95%
1500 (4921)	100%	100%	100%	100%	100%	100%	100%	100%	100%	95%	90%
2000 (6561)	100%	100%	100%	100%	100%	100%	95%	95%	95%	90%	90%
2500 (8202)	100%	100%	100%	100%	100%	100%	90%	90%	90%	85%	80%
3000 (9842)	100%	100%	100%	100%	100%	100%	90%	90%	90%	85%	80%
3500 (11,482)	90%	90%	90%	90%	90%	90%	80%	80%	80%	75%	75%
4000 (13,123)	80%	80%	80%	80%	80%	80%	80%	80%	80%	75%	75%
4500 (14,764)	75%	75%	75%	75%	75%	75%	75%	75%	75%	70%	65%
5000 (16,404)	65%	65%	65%	65%	65%	65%	65%	65%	65%	65%	65%

Power Distribution

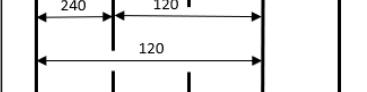
The main power is connected from the alternator through a 3-position voltage selector switch to the main power cubicle. The cubicle incorporates all power distribution, controls, sensing and protection devices.

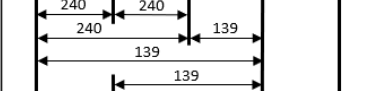
- ✓ 3-position Voltage Selector Switch (VSS)
- ✓ Current transformer x 3 (1 each leg)
- ✓ Single main breaker w/shunt trip
- ✓ Individual breakers for each receptacle
- ✓ Convenience receptacles located on outside of unit for easy access
- ✓ Terminal board for hard wiring
- ✓ Cam-Lock external quick connect (available as option)
- ✓ External emergency stop switch (recessed)
- ✓ Neutral bonded to Ground with a removable bonding link accessible in the control cubicle

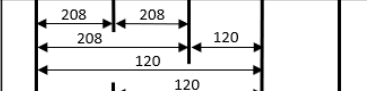
Please refer to the chart below for power distribution and voltages. NOTE: All voltages below are subject to change, depending on set point of "Fine Voltage Adjustment" potentiometer and Voltage Selector Switch.

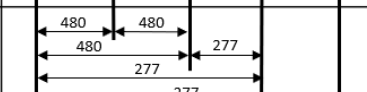
		120V Receptacle NEMA 5-20R	125/250V Receptacle CS6369	Terminal Board
Fine Voltage Adjustment *	Voltage Selector Switch Position			
	 240/120V 1Ø	120V	240/120V	
	 208/240V 3Ø	139V	240/139V	
	 208/240V 3Ø	120V	208/120V	
	 480V 3Ø	139V	240/139V	

*All voltages are adjustable with the "Fine Voltage Adjustment" potentiometer located on the control panel. Therefore, voltage may be different than what is shown in the above table. All voltages should be verified before connection to the unit.

Convenience Receptacles

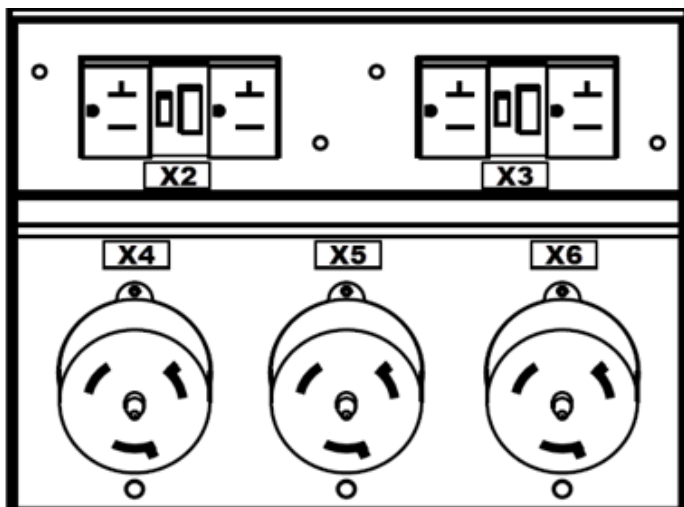

Receptacle	Type
X2, X3	120V - NEMA 5-20R GFCI (outlets)
X4, X5, X6	125/250V - CS6369 (outlets)

Controller

The QAS 95 & 125 come equipped with a Deep Sea 7310 control module. This is a fully diagnostic ECU controller with large 3" display, that is intuitive and easy to operate with all functions conveniently at your fingertips. The controller also manages the engine ECU operating system, and a number of safety warnings and shutdowns on various parameters (listed below).

The controller is powered by a main On/Off switch located next to unit.

DeepSea 7310 Controller Functionality:

Home Page (displayed while running, scrolling every 3seconds)

- ✓ Generator voltage (ph-ph)

Status Page

- ✓ Generator voltage (ph-N)
- ✓ Generator voltage (ph-ph)
- ✓ Generator frequency
- ✓ Generator kw
- ✓ Generator power factor
- ✓ Generator amperage

Generator Page

- ✓ Generator current (A)
- ✓ Generator earth current
- ✓ Generator load (kw)
- ✓ Generator load (kVA)
- ✓ Generator power factor
- ✓ Generator load (kVAr)
- ✓ Generator load (kWh, kVAh, kVArh)
- ✓ Generator phase sequence
- ✓ Dual mutual status

Event Page

- ✓ Displays the last 250 events

Remote Start/Stop

- ✓ Automatic start/stop via 2 wire dry contact connection

Operational Buttons

- ✓ Start button
- ✓ Stop button
- ✓ Automatic mode (external remote start)
- ✓ Up/Down arrows

Info Page

- ✓ Model number
- ✓ USB identification number
- ✓ Configured engine type
- ✓ Module's date and time
- ✓ Scheduler setting

Engine Page

- ✓ Engine speed
- ✓ Oil pressure
- ✓ Coolant temperature
- ✓ Engine battery volts
- ✓ Run Time
- ✓ Oil Temperature
- ✓ Fuel Temperature
- ✓ Turbo Pressure
- ✓ Fuel Pressure
- ✓ Fuel Consumption
- ✓ Fuel Used
- ✓ Fuel Level
- ✓ Auxiliary Sensors
- ✓ Engine Maintenance Due
- ✓ Engine ECU Link

Engine DTC Page

- ✓ This page contains any active Diagnostic Trouble Codes that the engine ECU is currently generating. These alarms are conditions detected by the engine ECU and displayed on the DSE controller.



Controller – Paralleling Option

The QAS 95 and QAS 125 JD T4F are also available as an option with a Qc4004 controller and Qd0701 capacitive touch screen display. This is a fully diagnostic ECU controller with large 7" diagonal (800 x 480 pixel) touch screen display that is intuitive and easy to operate with all functions conveniently at your fingertips. The controller also manages the engine ECU operating system, and a number of safety warnings and shutdowns on various parameters.

Additionally, our Power Management System (PMS) enables the optimization of fuel consumption and expands the generator lifetime. PMS manages the quantity of generators running in parallel with load demand, starting and stopping units in line with increases or decreases in load. This ensures the demand on each generator remains at a level which optimizes fuel consumption. This also eliminates the need for generators to run with low load levels, which can cause engine damage and shorten the life expectancy of the equipment.

Qc4004 Controller Benefits:

Modular Plant Capacity

- ✓ The Qc4004 controller allows up to 32 generators to be coupled in parallel to fit the power requirement of any application.

Remote communication capability

- ✓ The Qc4004 supports serial communication protocols including Modbus (RS-485, USB, and TCP/IP) and Profibus allowing you to supervise and control your genset/plant remotely.

User friendly rental interface

- ✓ Rental companies will benefit from the standardized user interfaces. The controller has been designed with ease of operation in mind, and rental companies can easily set and lock parameters to ensure full protection of their equipment.

Available Modes:

- ✓ **Island mode** - Power plant with synchronizing generators or a stand-alone generator. Also applicable in critical power plants.
- ✓ **Automatic Mains Failure** - Critical power/emergency standby plants, black start generator.
- ✓ **Fixed power** - Power plant with fixed kW set point (including building load).
- ✓ **Peak shaving** - Power plant where generator supplies peak load demand paralleled to the mains.
- ✓ **Load takeover** - Plant mode where the load is moved from mains to generator, for example peak demand periods or periods with risk of power outages.
- ✓ **Mains power export** - Power plant with fixed kW set point (excluding building load).
- ✓ **Remote maintenance** - Used when the generator must supply the load while a distribution transformer is disconnected for service.

* All modes are configurable, and it is possible to change the plant mode on the fly both in single and in power management applications.



Engine

John Deere 4045

John Deere Tier 4 Final, turbo charged, intercooled, four-cylinder, liquid-cooled diesel engine provides ample power to operate the generator continuously at full-load.

Meets all US EPA, CARB and Environment Canada exhaust legislations with Tier 4 Final compliance. The engine utilizes a Selective Catalytic Reduction (SCR) and Diesel Oxidation Catalyst (DOC) to meet final Tier 4 emissions. All functionality of the engine is controlled automatically on the Deep Sea 7310 controller.

The engine has the capability to start the generator at 14°F (-10°C) with standard glow-plug aid. A 1000W, 110V coolant heater comes as standard and allows a minimum starting temperature of -13°F (-25°C) when using cold weather option (including engine's variable speed fan and 0W40 synthetic engine oil).

The 166 gal (628L) fuel tank is sufficiently sized to operate the unit at full-load condition for long run times (see chart on page 2 for specifications).

The engine operates on a 12V negative ground electrical system with a 90A charging alternator. The cooling system is suitably designed for continuous operation in ambient conditions up to 122°F (50°C), with canopy door closed.

Fuel System

A large 166 gal (628L) plastic fuel tank provides safe diesel storage while eliminating tank corrosion contaminants from being introduced to your fuel system. With integrated fuel water separator and filter, the system is designed to help maintain clean and trouble-free diesel supply to the engine for reliable trouble-free operation.

- ✓ Pad-lockable diesel fill cap
- ✓ Fuel / Water separator
- ✓ Inline priming pump (w/ filter)
- ✓ Fuel pre-filter
- ✓ Fuel supply pump (w/ strainer)
- ✓ Fuel level sensor
- ✓ Low fuel shut down feature (programmable level)

Scheduled maintenance

Standard equipped with filters sized and designed to allow 500-hour service intervals under normal operating conditions. Extended time between services reduces downtime and total cost of ownership of the unit over its lifetime.

500 Hour Service Interval:

- ✓ Air filter
- ✓ Oil filter
- ✓ Fuel filter
- ✓ Fuel / water separator

1000 Hour Service Interval:

- ✓ Air filter
- ✓ Oil filter
- ✓ Fuel filter
- ✓ Fuel / water separator
- ✓ V-Belt

NOTE: Site specific operating conditions such as; poor fuel quality and low load profile may require more frequent service intervals.

Enclosure & Frame

The generator enclosure is designed for extreme applications to provide superior performance and reliability.

The enclosure is made of carbon steel, which is treated in a zinc rich primer then powder coated for optimal corrosion resistance and tested with salt spray for 6000 hours. The enclosure and frame are fully sealed from the radiator to the back of the unit, providing a true 110% containment of all fluids.

- ✓ 16Ga carbon steel, zinc rich primed, powder coated enclosure, 6000-hour salt spray tested
- ✓ Heavy duty, 7Ga carbon steel baseframe
- ✓ 110% fluid containment
- ✓ Larger 166 gal (628L), polyethylene fuel tank
- ✓ Convenient 2" NPT drain at rear of machine to clean out the containment frame
- ✓ Superior level of rain ingress protection and design features
- ✓ Pad-lockable doors and fuel cap
- ✓ Engine fluid plumbed to exterior of frame for ease of service
- ✓ Central lifting point
- ✓ Sound dampening material and design to allow quiet operation at 73 dB(A)

Undercarriage

The QAS 95 & 125 is available with two undercarriage alternatives, providing utmost flexibility in installation, site handling or towing. Both the skid frame and the trailer mount the same way and can be interchanged for versatility.

Trailer:

- ✓ Dual axle
- ✓ Available with electric (standard) or hydraulic (option) brakes
- ✓ DOT/Federal MVSS 49CFR571 approved light package and 7 flat blade RV style plug
- ✓ Adjustable height pintle hitch (3" lunette)
- ✓ 15" Rims w/ ST205/75D15 Tires for trailer use
- ✓ Heavy Duty torsion axles rated at 3,500 lbs each (total 7,000 lbs) w/ brakes
- ✓ GR40 5/16" Safety chains with 3/8" clevis slip hook and safety chain
- ✓ Screw jack leveling, with jockey wheel, 1,500 lbs static capacity
- ✓ Single point lifting structure
- ✓ D-Ring Tie down points x4

Skid mounted:

- ✓ Sub-frame skid with integrated forklift pockets
- ✓ Heavy duty design for use in extreme conditions
- ✓ Frame is 1/4" wider than machine to reduce damage from forklifts
- ✓ Built-in locations for straps or chains to secure the unit for transport
- ✓ Single point lifting structure

Factory Options Available

- Hydraulic brakes
- 2" or 2 5/16" ball hitches (shipped loose)
- Trailer stabilizer jacks
- Trailer mounted toolbox
- Spare Tire & mount
- Skid mount
- Cold weather kit (Variable Speed Fan + 0W40 synthetic engine oil)
- Fleetlink (Telematics system)
- Parallel Cubicle (includes Qc4004 controller + Touch Screen Display and Motorized Circuit Breaker)
- Battery charger (12V, 6A) – standard on SV* and RS** models
- External Fuel Tank connection (3-way valve) – standard on SV* and RS** models
- Solar charger (7W panel) – standard on RS** models
- Camlock quick connections (5 x 400A) – standard on RS** models

*SV = Stock Version

**RS = Rental Spec

Manufacturing & Environmental Standards

The **QAS 95 & 125 JD T4F** is manufactured following stringent ISO 9001 Quality Management requirements, and by a fully implemented Environmental Management & Occupational Health and Safety Systems fulfilling ISO 14001 & ISO 45001 requirements.



Attention has been given to ensure minimum negative impact to the environment.

The **QAS 95 & 125 JD T4F** meets all current US EPA, CARB and Environment Canada exhaust and noise emission directives.



Supplied Documentation

The unit is delivered with documentation regarding:

- Hard copies of the Atlas Copco Operators Safety and Instruction Manual, Atlas Copco Parts Book, John Deere Engine Manual and Parts book, in English as well as electronic copies available on request.
- Warranty Registration card for engine and Atlas Copco Generators (Units must be registered upon receipt).

Warranty Coverage

Atlas Copco Generator: Warrantied to be free from defects with regard to material and workmanship for the period of eighteen (18) months from date of shipment from the factory, or twelve (12) months from date of initial startup, whichever occurs first, without limitation of running hours.

John Deere Engine: John Deere Diesel engines are warrantied to be free from defects with regard to materials and workmanship for the period of twelve (12) months without limitations in running hours, or twenty-four (24) months prior to the accumulation of 2,000 hours from the date of invoicing from Atlas Copco.

Leroy Somer Alternator: Warrantied to be free from defects with regard to material and workmanship for the period of twenty-seven (27) months from date of shipment from the factory, or twenty-four (24) months from date of initial startup or 10,000 hours, whichever occurs first.

Extended Warranty Programs: Programs are available; please contact your local sales representative for more info.